



## PATIENT GUIDE



Drainage Frequency:

---

---

Dressing Frequency:

- Every Drainage
- Weekly Drainage

**Physician Contact  
Information**

Dr. \_\_\_\_\_

Phone: \_\_\_\_\_

# CHEST DRAINAGE

Pleural Space

Insertion Site

Cuff

Exit Site

Catheter

Valve

Connector

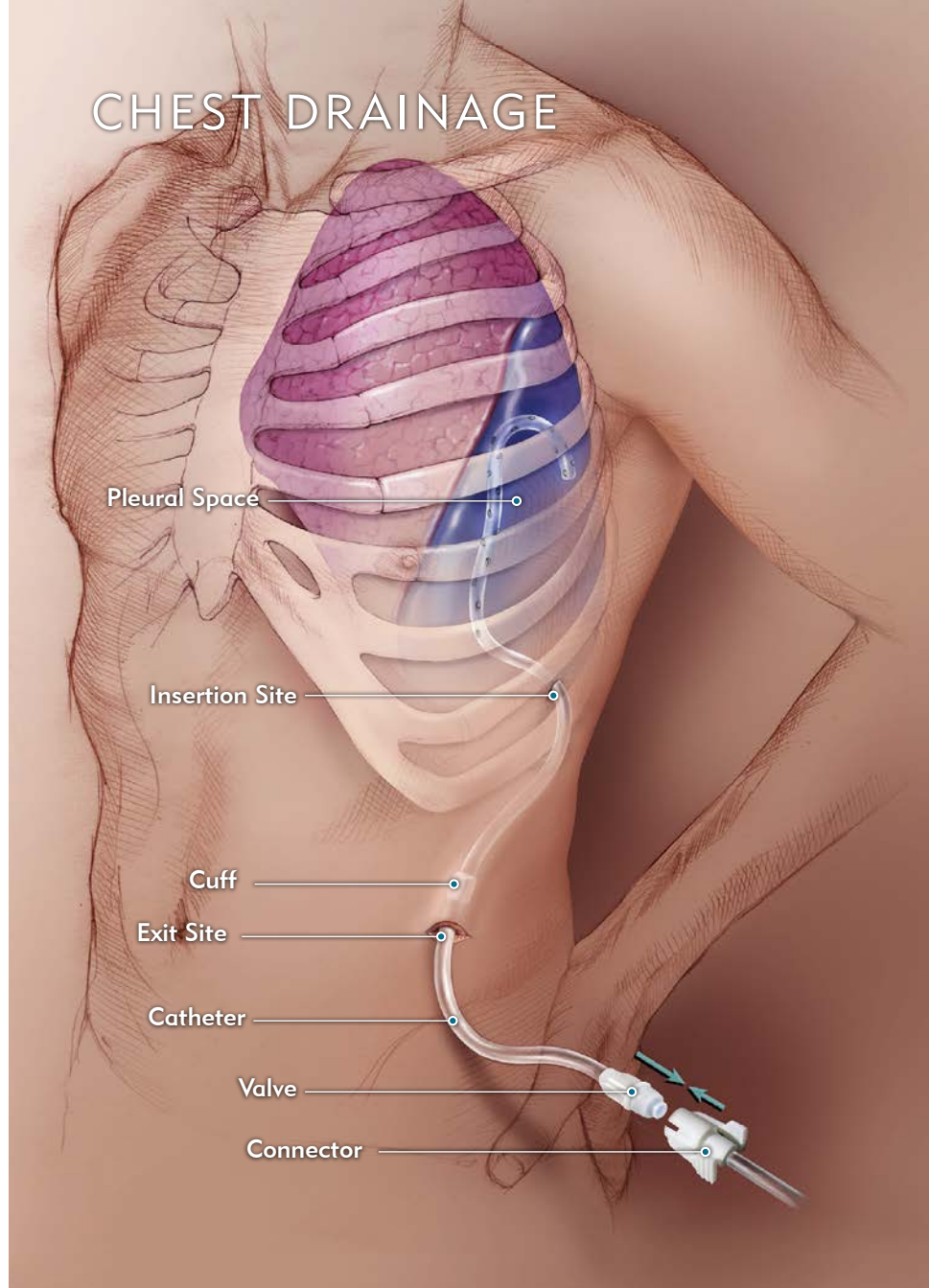

# CONTENTS

General Information About Your Aspira® Drainage Catheter	2
How To Drain Fluid From Your Aspira Drainage Catheter Using A Drainage Bag	4
How To Care For And Dress Your Aspira Drainage Catheter	10
How to Discard Fluid and Used Supplies	16
Possible Problems	17
Frequently Asked Questions	20
Glossary	22
Drainage Record	23

**WARNING: Check packages for damage before opening.  
Do not use if package is damaged.**

# GENERAL INFORMATION ABOUT YOUR ASPIRA® DRAINAGE CATHETER

## **Why do you have an Aspira Drainage Catheter?**

Your doctor has put an Aspira Drainage Catheter in your chest or abdomen to drain fluid in those areas. The catheter lets you drain fluid at home. Fluid drainage can help prevent or reduce shortness of breath or other symptoms.

## **Where does the catheter go inside the body?**

Please see the inside covers for illustrations. Your doctor may have put the catheter in your chest (pleural space) or in your abdomen (peritoneal cavity). The doctor made a small cut (insertion site) in your chest or abdominal wall. The doctor tunneled the catheter through the insertion site under the skin to the place where the catheter exits your body through another small cut (exit site). You may have a few stitches at the insertion site and exit site. You will need to clean the exit site every time you change the dressing on your catheter.

## **How does the Aspira Drainage Catheter and Aspira Drainage Kit work?**

The Aspira Drainage Catheter is a soft silicone tube. This tube has many holes on one end. This end is inside your body. The fluid enters these holes and flows into the catheter. The other end of the catheter has a valve.

When you connect the Aspira Drainage Bag to the catheter, the valve opens. For details related to draining with the bag, see page 4.

When no more fluid is flowing into the drainage bag or the bag is full, unhook the drainage bag from your catheter. Empty the drainage bag into the toilet and throw it in the trash. **Do not re-use.** Do not place it in the recycling bin.

It is important that you know how to drain and care for your catheter. You should have been given personal step-by-step instructions by your doctor or nurse. The information in this booklet is for reference only. Please call your doctor or nurse if you still have questions after reading this guide. You may also view a step-by-step video on how to drain and care for your catheter at [www.myaspira.com](http://www.myaspira.com) or call Customer Service to request a DVD at 1-800-356-3748 (toll free).

# HOW TO DRAIN FLUID FROM YOUR ASPIRA DRAINAGE CATHETER USING A DRAINAGE BAG

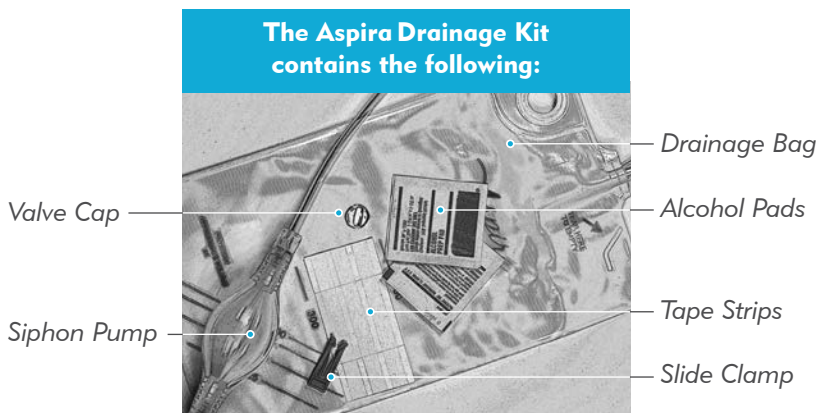

## Step 1 Prepare the Workspace

- Clear a space on a table or counter for your drainage supplies.
- Clean the surface with a disinfecting wipe or clean paper towel that has been moistened with rubbing alcohol. Wipe the surface dry with a fresh paper towel or allow it to air dry. This will create a clean work space.

**NOTE: Moisture, disinfecting wipes and/or rubbing alcohol may cause damage to some furniture surfaces.**

- Wash your hands with warm soapy water. Scrub for one full minute. Rinse. Dry using a clean towel or clean paper towels.

- d. Peel open the pouch containing the drainage kit.
- e. Place the supplies on the cleaned area.

**Remove dressing ONLY if:**

- 1 It has been one week since you last changed the dressing.  
- OR -
- 2 Your doctor has recommended that you change your dressing every time you drain fluid.  
- OR -
- 3 The area under the dressing is moist.

**NOTE:** If the catheter is damaged, place the slide clamp (in drainage kit) between the catheter damage and the exit site. Contact your doctor. To prevent damage, do not use anything sharp that may poke, cut or damage the catheter.

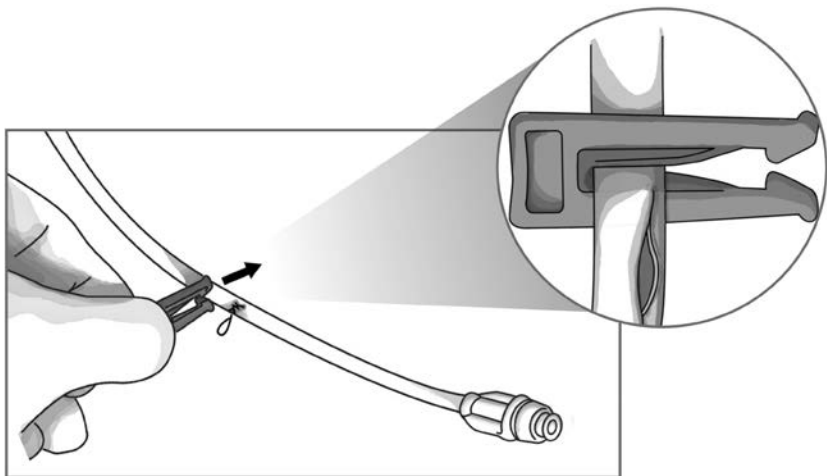

- f. Wash your hands with warm soapy water. Scrub for one full minute. Rinse. Dry using a clean towel or clean paper towels.

**NOTE: If the catheter is taped to the skin with tape strips, remove the tape.**

- g. Remove and discard the catheter valve cap from the catheter valve.

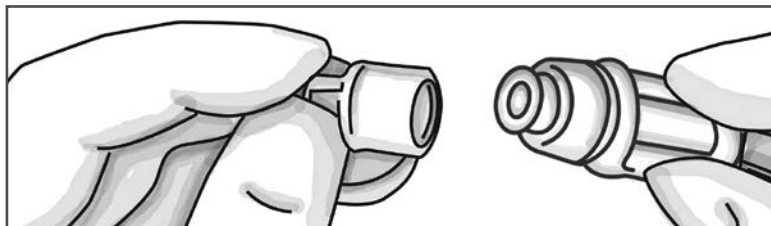

## Step 2 Drain Fluid

- a. Wipe the end of the valve with an alcohol pad. (1)
- b. Pick up the connecting end of the drainage bag line and push it onto the end of the catheter until you hear or feel a click. (2) Gently tug on the drainage line to make sure the connection is secure.
- c. Place the bag on a flat surface at least arm's length **below your chest or abdomen**. (3)
- d. Gently squeeze the siphon pump one time to initiate flow. It will slowly re-expand as fluid fills the pump. Let fluid drain until the bag is full or the fluid stops flowing. (4)

**NOTE: If the pump does not re-expand or re-expands but does not fill with fluid, check the connection. Gently squeeze the pump again. If this does not work, try again with a new drainage kit. If a new drainage kit does not start flow, contact your doctor.**



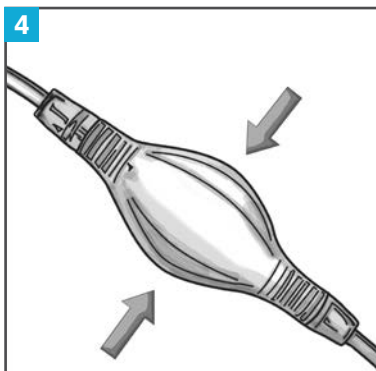
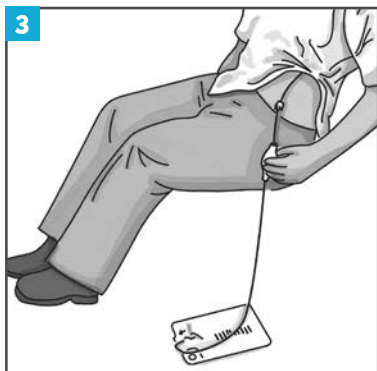
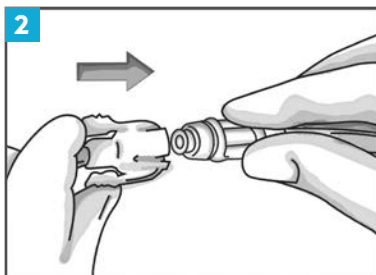
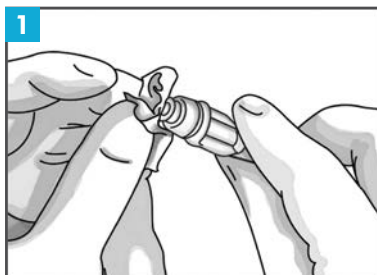

**NOTE:** If you have pain during drainage, raise the bag to slow the drainage or disconnect the bag to stop the flow of fluid. If you disconnect the bag, place the connecting end on your cleaned workspace. To restart the flow of fluid, clean the valve with a new alcohol wipe, connect the bag to the catheter and gently squeeze the pump. Do not reconnect a used bag that has been disconnected for more than 30 minutes.

**CAUTION:** Do not drain more than 1,000 mL from the chest or more than 2,000 mL from the abdomen in any one drainage session. Always follow the advice of your doctor.

**CAUTION:** If you have any of the following symptoms, complete the drainage and contact your doctor:

- Shortness of breath that isn't relieved after draining 1,000 mL from the chest or 2,000 mL from the abdomen at one time.
- On-going pain or shortness of breath but little or no fluid is draining from the catheter.
- Less than 25-50 mL drain during each drainage for 3 drainages in a row.
- The appearance of your fluid changes a lot between drainages. If you develop a fever (body temperature above 100.5° F [38° C]), notice redness, swelling, oozing or have pain at the exit site. These may be signs of infection that may require treatment. Consult your doctor immediately.

### Step 3 Complete your Drainage

- a. When fluid flow stops or the bag is full, hold the catheter with one hand and pinch the wings of the connector with the other hand until the connector easily comes away from the catheter.



- b. Allow any fluid left in the tube to drain into the bag. Set the bag to the side.

- c. Wipe the catheter valve with a new alcohol pad.

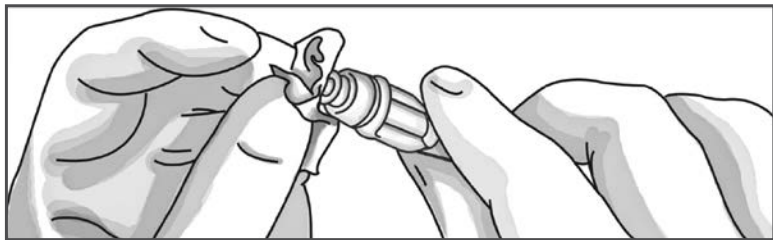

- d. Place the new valve cap on the valve.

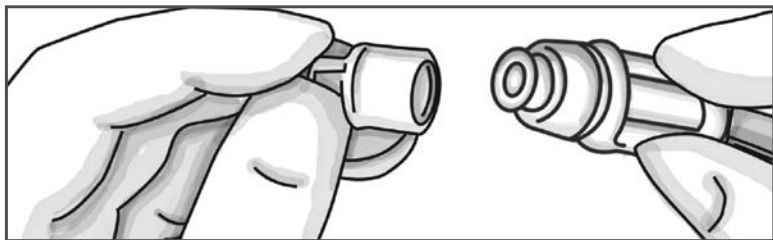

- e. **Optional:** If it is not time to change your dressing, tape the catheter to the skin where it is most comfortable. Go to the section titled “How to Discard Fluid and Used Supplies” on page 16.

**NOTE:** If it is time to change your dressing, go to the section titled “How To Care For and Dress Your Aspira Drainage Catheter” on page 10.

## HOW TO CARE FOR AND DRESS YOUR ASPIRA DRAINAGE CATHETER

You should change your dressing at least **once a week** or as often as you were told to by your doctor or nurse. You should also change the dressing if the area under the clear dressing becomes moist.



- a. Carefully remove the clear dressing, gauze and split catheter pad from your catheter.

**NOTE:** If the catheter is damaged, place the slide clamp, provided in the drainage kit, between the catheter damage and the exit site and contact your doctor. To prevent damage, do not use anything sharp that may poke, cut or damage the catheter.

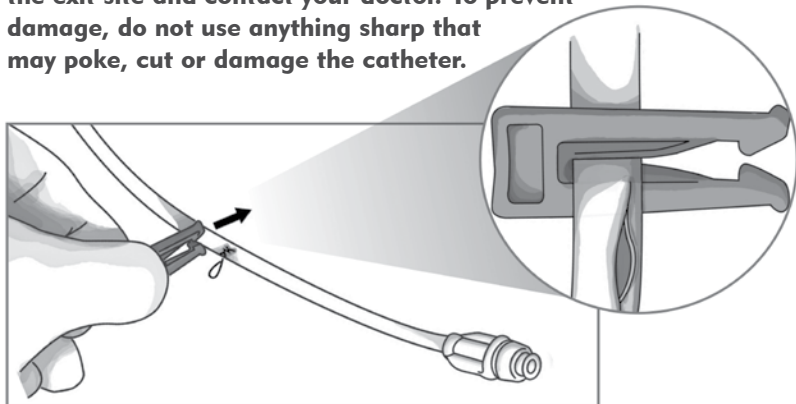

b. Wash your hands with warm soapy water. Scrub for one full minute. Rinse. Dry using a clean towel or clean paper towels.

c. Peel open the pouch with the dressing kit.

**NOTE:** Do not touch any unclean surface such as your skin, clothing, or furniture with your gloves.

d. Remove the gloves from the pouch.

e. Pick up one glove at the cuff end and place it on your hand. Pick up the second glove with the newly gloved hand and place it on your other hand.

f. Remove the blue CSR wrap from the pouch and place it on the clean work space. Pull on the corner sticking out of the edge of the sheet to open it.

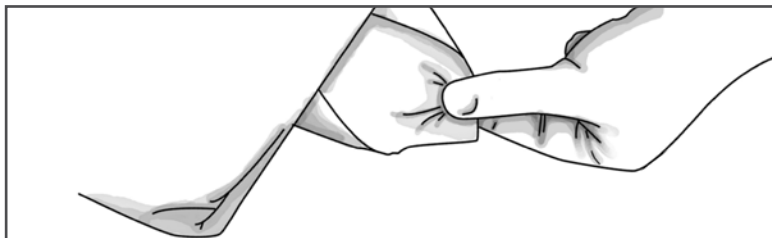

- g. Lay the sheet flat so you can see the dressing supplies.
- h. Clean the skin around the catheter exit site with an alcohol pad.



**CAUTION:** If you develop fever (body temperature above 100.5° F [38° C]), notice redness, swelling, oozing or have pain at the exit site, these may be signs of infection that may require treatment. Consult with your doctor immediately.

**NOTE:** Make sure the exit site and skin around the catheter are dry before completing the dressing.

- i. Place the split catheter pad on the skin around the catheter.
- j. If you change your dressing every time you drain, coil the catheter on top of the pad. If you change your dressing less often than you drain, lay the catheter down toward your waist.

**Dress at every drainage**

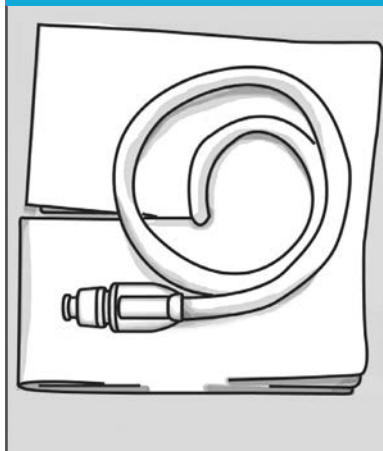

**Dress less often**

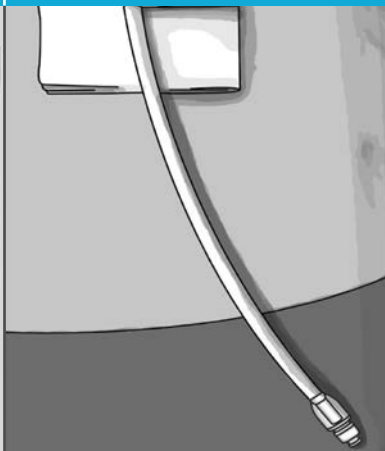

k. Place gauze over the top of the catheter.

**Dress at every drainage**

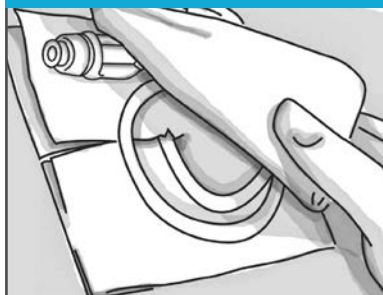

**Dress less often**



I. Hold gauze, catheter and split pad in place with one hand.

**NOTE: For the next step, you may need the help of a caregiver. Make sure the caregiver washes their hands, scrubbing for one full minute rinsing and drying on a clean paper towel or towel before helping dress the exit site.**

m. Remove the inside rectangle from the dressing, then remove the printed backing. Place the clear dressing over the catheter and gauze. Make sure the dressing sticks to the skin around the gauze. Remove the paper edge from the dressing and smooth down the dressing edges. Be careful, the clear dressing is very sticky.

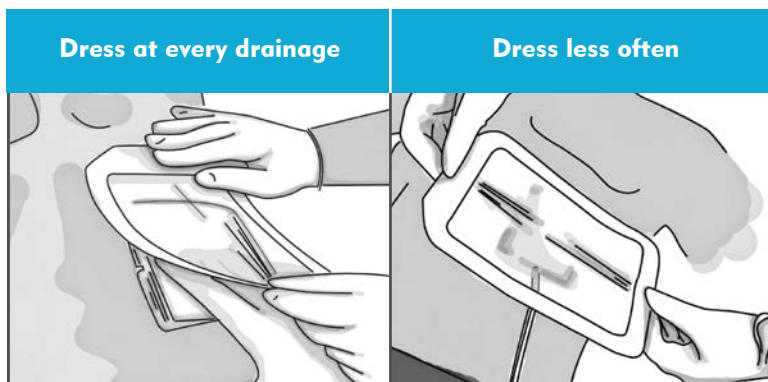

**NOTE:** If you change your dressing every time you drain fluid, your dressing is now complete. Any left over supplies can be thrown away. You may go to the section titled “How To Discard Fluid And Used Supplies” found on page 16. If you dress your catheter less often, continue with these final steps before going to the next section.



- n. If you left the catheter hanging down, tape the rest of the catheter to the skin where it is most comfortable.

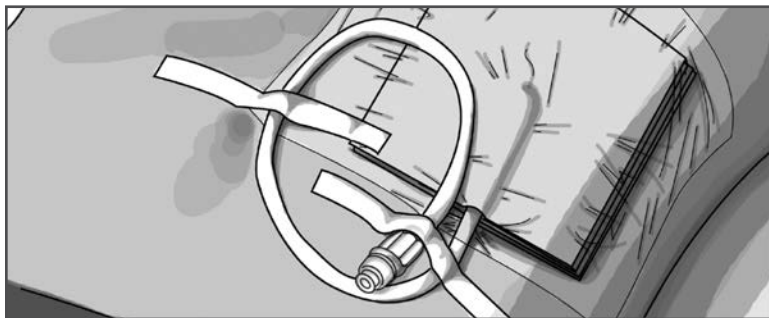

## HOW TO DISCARD FLUID AND USED SUPPLIES

- a. While holding over the toilet, cut or tear the corner of the drainage bag where the "cut or tear here to empty" arrow is pointing.

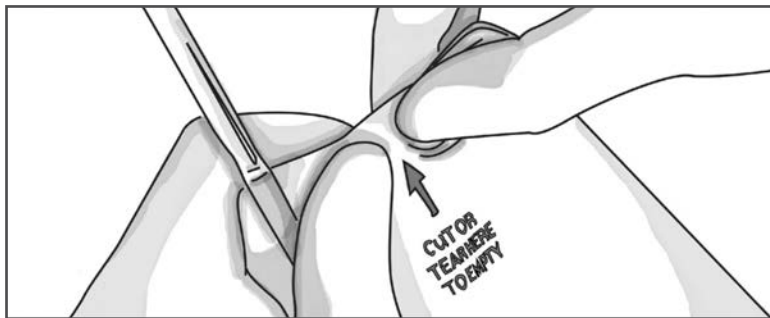

- b. Empty the fluid in the toilet. Flush the toilet.
- c. Coil the drainage line around the empty drainage bag. Place it in a small plastic bag and throw away.
- d. Throw all other used supplies in the trash.
- e. Wash your hands with warm soapy water. Rinse.

**CAUTION:** If fluid spills, be sure to clean using soap and warm water for clothing and skin and using bleach for household items.

**NOTE:** Don't place the used Aspira Drainage Bag in a recycling bin.

## POSSIBLE PROBLEMS

Infection		
Signs:	What to do:	How to help prevent it:
If you develop fever (Body temperature above 100.5° F [38° C]), or notice redness, swelling or oozing or have pain at the exit site. These may be signs of infection that may require treatment.	Call your doctor right away.	Clean the exit site regularly. Follow the directions in this booklet for a clean procedure whenever accessing the catheter.

Pain During Fluid Drainage		
Signs:	What to do:	How to help prevent it:
Pain while draining fluid with the Aspira Drainage Bag.	If you have pain while draining, raise the bag to slow the flow. Disconnect the bag to stop the flow. If your pain does not go away after you stop draining, contact your doctor.	Do not drain more fluid than your doctor tells you for each drainage.

### Slow or No Drainage

Signs:	What to do:	How to help prevent it:
Unable to drain fluid or very little fluid drains during procedures.	<ul style="list-style-type: none"><li>• Make sure the bag is placed at least arm's length below your chest or abdomen.</li><li>• Make sure the drainage line and the catheter are not kinked.</li><li>• Make sure the catheter and drainage line are securely connected.</li><li>• Gently squeeze the pump again to start the fluid flow. If this does not work, try changing your body position. If the fluid flow does not improve, call your doctor. The catheter may need to be checked.</li></ul>	Slow or no drainage could be caused by many things, most of which are out of your control. Call your doctor.

### Break Or Accidental Cut In The Catheter

Signs:	What to do:	How to help prevent it:
Leaking fluid	Place the slide clamp between the damaged area and your skin. Call your doctor immediately. The catheter will need to be repaired by your doctor.	Don't use sharp objects around the catheter. Never use a lot of force on the catheter.

### Catheter Valve Damage

Signs:	What to do:	How to help prevent it:
Leaking fluid around the catheter valve.	Place the supplied slide clamp close to the valve on the catheter. Call your doctor. The catheter valve will need to be replaced.	Don't use a lot of force on the catheter valve or catheter when connecting and removing the Aspira Drainage Bag. Do not try to connect anything but the drainage bag to the catheter valve.

### Accidental Catheter Removal

Signs:	What to do:	How to help prevent it:
The catheter moves in and out of the exit site. The cuff may break through the skin.	Call your doctor immediately. If the catheter comes all the way out of your chest or abdomen, place a clean dressing on the exit site.	Don't pull, tug or yank on the catheter. Be careful that it does not get caught or snagged.

### Low Blood Pressure During Or After Drainage

Signs:	What to do:	How to help prevent it:
Dizziness or feeling light headed, blurred vision, feeling faint or weak.	Stop draining. Call your doctor.	Don't drain more fluid than your doctor tells you at each drainage.

## FREQUENTLY ASKED QUESTIONS

### **Can I shower with the catheter?**

You may shower if a water tight covering is placed securely over the catheter. Do not bathe or allow the catheter or catheter exit site to soak under water. If the area under the clear dressing becomes wet, remove the dressing, and dry and dress the area with a new dressing kit.

### **How often do I need to drain fluid?**

You should drain fluid as often as your doctor tells you to. Your doctor may have you drain fluid to relieve symptoms.

### **How long can the catheter stay in place?**

Your doctor will decide how long you need the catheter. It can stay in place as long as you need it, provided that you don't have any complications.

### **How often do I need to change the dressing?**

You should change the dressing at least once a week or as often as your doctor tells you to. You should also apply a clean dressing if the area under the clear dressing becomes wet or if the clear dressing is damaged. See, "How to Care For and Dress Your Aspira Drainage Catheter" on page 10.

### **Naturally this patient guide can not cover all potential questions, possible situations and scenarios.**

Contact your doctor with any questions or concerns.

### **How do I order more drainage and dressing kits?**

Drainage bag and dressing kit orders should be ordered through our preferred distributors. Using the information listed on the next page, please contact the distributor in your region immediately upon discharge to confirm the delivery of your supplies.

Patients living in the Eastern Time Zone:	Patients living outside of the Eastern Time Zone:
Advanced Care Solutions/ Complete Medical Supplies Phone: 877-748-1977 Fax: 866-634-8166	180 Medical Phone: 800-948-1868 Fax: 877-396-6235

REORDER NUMBERS	
1L Drainage Bag (1,000 mL Pleural/Peritoneal)	Dressing Kit
4992301	4991503

### Who should I call if I have questions about my catheter?

For general questions on how to use your catheter, you may call the clinical information line at 1-833-3ASPIRA (327-7472) toll free. You may also call your doctor or nurse.

### Where can I find a video to explain how to care for and drain fluid from my Aspira Drainage Catheter?

If your doctor or nurse did not provide a DVD, you may find the patient drainage video on [www.myaspira.com](http://www.myaspira.com) or request a DVD by calling Customer Service at 1-800-356-3748 toll free.

**Disclaimer:** All of the answers provided are suggestions, and only your doctor can make the appropriate decisions based on your particular clinical situation and need. Your doctor's advice overrides any of the recommendations provided in this patient guide.

## GLOSSARY

**Ascites** Fluid that builds up in the abdomen.

**Catheter** Soft silicone (plastic) tube that is placed inside the body.

**Cuff** Small piece of mesh around the catheter that helps the catheter stay in place while inside the body.

**Exit Site** Small cut where the catheter comes out of the skin.

**Insertion Site** Small cut where the catheter is inserted by the doctor.

**Peritoneal Space** Space surrounding the abdominal organs where fluid may build up.

**Peritoneum** Membrane that lines the inside of the abdomen and surrounds the abdominal organs.

**Pleural Effusion** Fluid that builds up in the pleural space.

**Pleural Space** Area between the lungs and the chest wall where fluid may build up.



## DRAINAGE RECORD

Date	Volume (mL)	Notes

Date	Volume (mL)	Notes

<b>Date</b>	<b>Volume (mL)</b>	<b>Notes</b>



REORDER NUMBERS	
1L Drainage Bag (1,000 mL Pleural/Peritoneal)	Dressing Kit
4992301	4991503

# ABDOMEN DRAINAGE

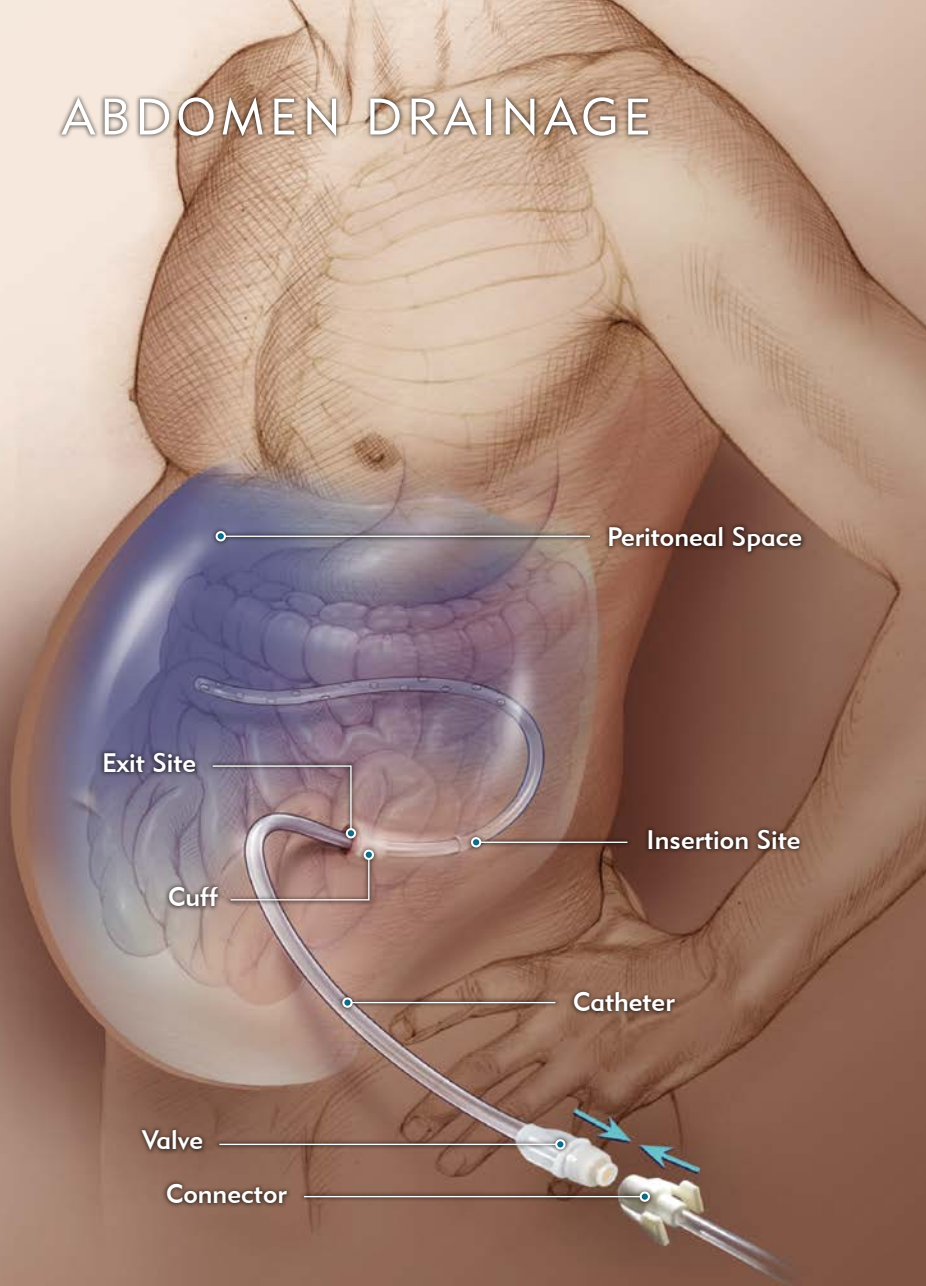

[myaspira.com](http://myaspira.com)

404624001\_003 ID021919